

User Manual

# GETTING STARTED? EASY.



ZOPNX6K2  
ZOPNX6X2

EN User Manual  
Oven

# ZANUSSI

## VISIT OUR WEBSITE TO:

---



Get usage advice, brochures, trouble shooter, service and repair information:  
[www.zanussi.com/support](http://www.zanussi.com/support)

## SAFETY INFORMATION

---

Before the installation and use of the appliance, carefully read the supplied instructions. The manufacturer is not responsible for any injuries or damage that are the result of incorrect installation or usage. Always keep the instructions in a safe and accessible location for future reference.

## **CHILDREN AND VULNERABLE PEOPLE SAFETY**

- This appliance can be used by children aged from 8 years and above and persons with reduced physical, sensory or mental capabilities or lack of experience and knowledge if they have been given supervision or instruction concerning the use of the appliance in a safe way and understand the hazards involved. Children of less than 8 years of age and persons with very extensive and complex disabilities shall be kept away from the appliance unless continuously supervised.
- Children should be supervised to ensure that they do not play with the appliance.
- Keep all packaging away from children and dispose of it appropriately.
- **WARNING:** Keep children and pets away from the appliance when it operates or when it cools down. Accessible parts become hot during use.
- If the appliance has a child safety device, it should be activated.
- Children shall not carry out cleaning and user maintenance of the appliance without supervision.

## **GENERAL SAFETY**

- Only a qualified person must install this appliance and replace the cable.
- Do not use the appliance before installing it in the built-in structure.

- Disconnect the appliance from the power supply before carrying out any maintenance.
- If the mains power supply cable is damaged, it must be replaced by the manufacturer, its Authorised Service Centre or similarly qualified persons to avoid an electrical hazard.
- The means for disconnection must be incorporated in the fixed wiring in accordance with the wiring rules.
- **WARNING:** Ensure that the appliance is switched off before replacing the lamp to avoid the possibility of electric shock.
- **WARNING:** The appliance and its accessible parts become hot during use. Care should be taken to avoid touching heating elements.
- Always use oven gloves to remove or put in accessories or ovenware.
- To remove the shelf supports first pull the front of the shelf support and then the rear end away from the side walls. Install the shelf supports in the opposite sequence.
- Do not use a steam cleaner to clean the appliance.
- Do not use harsh abrasive cleaners or sharp metal scrapers to clean the glass door since they can scratch the surface, which may result in shattering of the glass.
- Excessive spillage must be removed before the pyrolytic cleaning. Remove all parts from the oven.

## SAFETY INSTRUCTIONS

### INSTALLATION



**WARNING!** Only a qualified person must install this appliance.

- Remove all the packaging.
- Do not install or use a damaged appliance.
- Follow the installation instructions supplied with the appliance.
- Always take care when moving the appliance as it is heavy. Always use safety gloves and enclosed footwear.
- Do not pull the appliance by the handle.
- Install the appliance in a safe and suitable place that meets installation requirements.
- Keep the minimum distance from other appliances and units.

- Before mounting the appliance, check if the oven door opens without restraint.
- The appliance is equipped with an electric cooling system. It must be operated with the electric power supply.

Cabinet minimum height (Cabinet under the worktop minimum height)	580 (600) mm
Cabinet width	560 mm
Cabinet depth	550 (550) mm
Height of the front of the appliance	589 mm

Height of the back of the appliance	571 mm
Width of the front of the appliance	595 mm
Width of the back of the appliance	559 mm
Depth of the appliance	569 mm
Built in depth of the appliance	548 mm
Depth with open door	1022 mm
Ventilation opening minimum size. Opening placed on the bottom rear side	560x20 mm
Mounting screws	4x25 mm

## ELECTRICAL CONNECTION



**WARNING!** Risk of fire and electric shock.

- All electrical connections should be made by a qualified electrician.
- The appliance must be earthed.
- Make sure that the parameters on the rating plate are compatible with the electrical ratings of the mains power supply.
- Always use a correctly installed shockproof socket.
- Do not use multi-plug adapters and extension cables.
- Make sure not to cause damage to the mains plug and to the mains cable. Should the mains cable need to be replaced, this must be carried out by our Authorised Service Centre.
- Do not let mains cables touch or come near the appliance door or the niche below the appliance, especially when it operates or the door is hot.
- The shock protection of live and insulated parts must be fastened in such a way that it cannot be removed without tools.
- Connect the mains plug to the mains socket only at the end of the installation. Make sure that there is access to the mains plug after the installation.
- If the mains socket is loose, do not connect the mains plug.
- Do not pull the mains cable to disconnect the appliance. Always pull the mains plug.
- Use only correct isolation devices: line protecting cut-outs, fuses (screw type fuses

removed from the holder), earth leakage trips and contactors.

- The electrical installation must have an isolation device which lets you disconnect the appliance from the mains at all poles. The isolation device must have a contact opening width of minimum 3 mm.
- Fully close the appliance door before you connect the mains plug to the mains socket.
- This appliance is supplied without a main plug and a main cable.

## Cable types applicable for installation or replacement for Europe:

H07 RN-F, H05 RN-F, H05 RRF, H05 VV-F, H05 V2V2-F (T90), H05 BB-F

For the section of the cable refer to the total power on the rating plate. You can also refer to the table:

Total power (W)	Section of the cable (mm <sup>2</sup> )
maximum 1380	3 x 0.75
maximum 2300	3 x 1
maximum 3680	3 x 1.5

The earth cord (green / yellow cable) must be 2 cm longer than phase and neutral cables (blue and brown cables).



## USE



**WARNING!** Risk of injury, burns and electric shock or explosion.

- This appliance is for household (indoors) use only.
- Do not change the specification of this appliance.
- Make sure that the ventilation openings are not blocked.
- Do not let the appliance stay unattended during operation.
- Deactivate the appliance after each use.
- Be careful when you open the appliance door while the appliance is in operation. Hot air can release.

- Do not operate the appliance with wet hands or when it has contact with water.
- Do not apply pressure on the open door.
- Do not use the appliance as a work surface or as a storage surface.
- Open the appliance door carefully. The use of ingredients with alcohol can cause a mixture of alcohol and air.
- Do not let sparks or open flames to come in contact with the appliance when you open the door.
- Do not put flammable products or items that are wet with flammable products in, near or on the appliance.
- Replace immediately the door glass panels when they are damaged. Contact the Authorised Service Centre.
- Be careful when you remove the door from the appliance. The door is heavy!
- Clean regularly the appliance to prevent the deterioration of the surface material.
- Clean the appliance with a moist soft cloth. Use only neutral detergents. Do not use abrasive products, abrasive cleaning pads, solvents or metal objects.
- If you use an oven spray, follow the safety instructions on its packaging.



**WARNING!** Risk of damage to the appliance.

- To prevent damage or discoloration to the enamel:
  - do not put ovenware or other objects in the appliance directly on the bottom.
  - do not put aluminium foil directly on the bottom of cavity of the appliance.
  - do not put water directly into the hot appliance.
  - do not keep moist dishes and food in the appliance after you finish the cooking.
  - be careful when you remove or install the accessories.
- Discoloration of the enamel or stainless steel has no effect on the performance of the appliance.
- Use a deep pan for moist cakes. Fruit juices cause stains that can be permanent.
- This appliance is for cooking purposes only. It must not be used for other purposes, for example room heating.
- Always cook with the oven door closed.
- If the appliance is installed behind a furniture panel (e.g. a door) make sure the door is never closed when the appliance operates. Heat and moisture can build up behind a closed furniture panel and cause subsequent damage to the appliance, the housing unit or the floor. Do not close the furniture panel until the appliance has cooled down completely after use.

## CARE AND CLEANING



**WARNING!** Risk of injury, fire, or damage to the appliance.

- Before maintenance, deactivate the appliance and disconnect the mains plug from the mains socket.
- Make sure the appliance is cold. There is the risk that the glass panels can break.

## PYROLYTIC CLEANING



**WARNING!** Risk of Injury / Fires / Chemical Emissions (Fumes) in Pyrolytic Mode.

- Before carrying out a Pyrolytic self-cleaning function or the First Use please remove from the oven cavity:
  - any excess food residues, oil or grease spills / deposits.
  - any removable objects (including shelves, side rails etc., provided with the product) particularly any non-stick pots, pans, trays, utensils etc.
- Read carefully all the instructions for Pyrolytic cleaning.
- Keep children away from the appliance while the Pyrolytic cleaning operates. The appliance becomes very hot and hot air is released from the front cooling vents.
- Pyrolytic cleaning is a high temperature operation that can release fumes from cooking residues and construction materials, as such consumers are strongly advised to:
  - provide good ventilation during and after each Pyrolytic cleaning.
  - provide good ventilation during and after the first use at maximum temperature operation.
- Unlike all humans, some birds and reptiles can be extremely sensitive to potential fumes emitted during the cleaning process of all Pyrolytic Ovens.
  - Remove any pets (especially birds) from the vicinity of the appliance location during and after the Pyrolytic cleaning and first use maximum temperature operation to a well ventilated area.
- Small pets can also be highly sensitive to the localized temperature changes in the vicinity of all Pyrolytic Ovens when the Pyrolytic self cleaning program is in operation.

- Non-stick surfaces on pots, pans, trays, utensils etc., can be damaged by the high temperature Pyrolytic cleaning operation of all Pyrolytic Ovens and can be also a source for low level harmful fumes.
- Fumes released from all Pyrolytic Ovens / Cooking Residues as described are not harmful to humans, including children, or persons with medical conditions.

- be used in other applications and are not suitable for household room illumination.
- Use only lamps with the same specifications.

### SERVICE

- To repair the appliance contact the Authorised Service Centre.
- Use original spare parts only.

### DISPOSAL

- **WARNING!** Risk of injury or suffocation.
- Contact your municipal authority for information on how to dispose of the appliance.
- Disconnect the appliance from the mains supply.
- Cut off the mains electrical cable close to the appliance and dispose of it.
- Remove the door catch to prevent children or pets from becoming trapped in the appliance.

### INTERNAL LIGHTING



**WARNING!** Risk of electric shock.

- Concerning the lamp(s) inside this product and spare part lamps sold separately: These lamps are intended to withstand extreme physical conditions in household appliances, such as temperature, vibration, humidity, or are intended to signal information about the operational status of the appliance. They are not intended to

## INSTALLATION



**WARNING!** Refer to Safety chapters.

### BUILDING IN

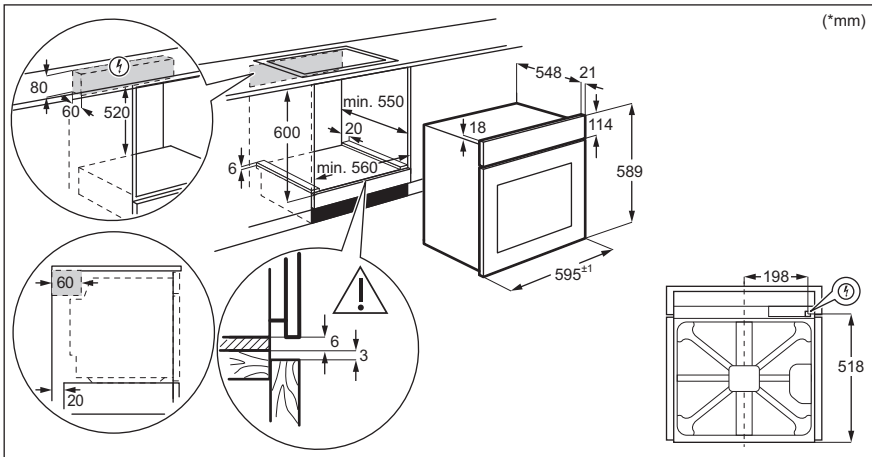

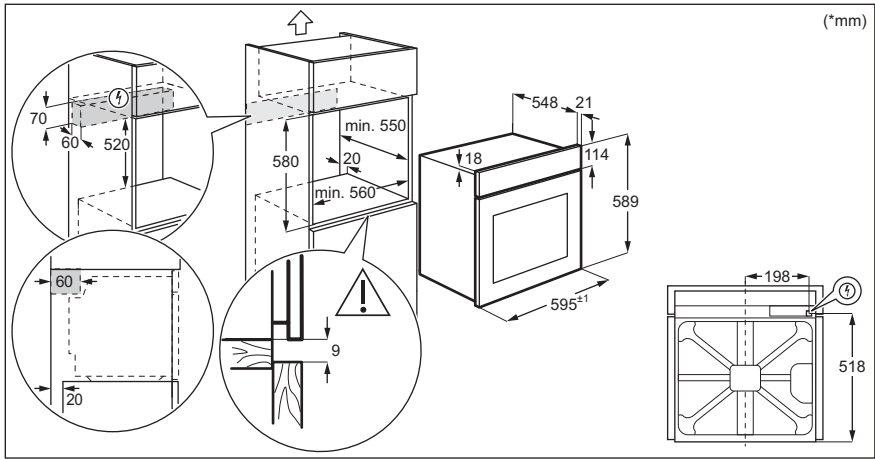

### SECURING THE OVEN TO THE CABINET

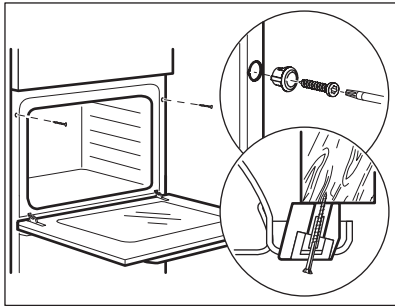

# PRODUCT DESCRIPTION

## GENERAL OVERVIEW

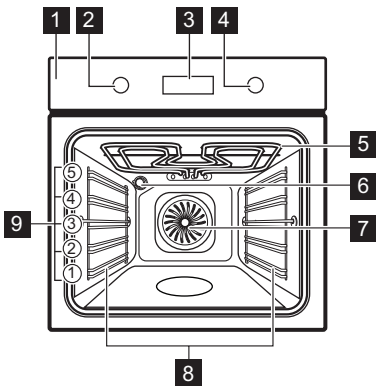

- 1 Control panel
- 2 Knob for the heating functions
- 3 Display
- 4 Control knob (for the temperature)
- 5 Heating element
- 6 Lamp
- 7 Fan
- 8 Shelf support, removable
- 9 Shelf positions

## ACCESSORIES

- **Wire shelf**  
For cookware, cake tins, roasts.
- **Grill- / Roasting pan**  
To bake and roast or as pan to collect fat.
- **Trivet**

For roasting and grilling.





Use the trivet only with the Grill- / roasting pan.

## CONTROL PANEL

### RETRACTABLE KNOBS

To use the appliance press the knob. The knob comes out.

### SENSOR FIELDS / BUTTONS

	To set the MINUTE MINDER. Hold it for more than 3 seconds to turn on or turn off the oven lamp.
	To set a clock function.
	To check the oven temperature or the temperature of the core temperature sensor (if applicable). Use only while a heating function operates.



## DISPLAY

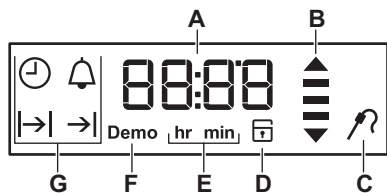

- A. Timer / Temperature
- B. Heat-up and residual heat indicator
- C. Food Sensor (selected models only)
- D. Door lock (selected models only)
- E. Hours / minutes
- F. Demo Mode (selected models only)
- G. Clock functions

## BEFORE FIRST USE



**WARNING!** Refer to Safety chapters.



Set the time before you use the oven.

### INITIAL CLEANING

Step 1	Step 2	Step 3
Remove all accessories and removable shelf supports from the oven.	Clean the oven and the accessories with a soft cloth, warm water and a mild detergent.	Place the accessories and the removable shelf supports in the oven.

### INITIAL PREHEATING

**Preheat the empty oven before the first use.**

<b>Step 1</b>	Remove all accessories and removable shelf supports from the oven.
<b>Step 2</b>	Set the maximum temperature for the function:  Let the oven operate for 1 h.
<b>Step 3</b>	Set the maximum temperature for the function:  Let the oven operate for 15 min.

 The oven can emit an odour and smoke during preheating. Make sure that the room is ventilated.

## DAILY USE



**WARNING!** Refer to Safety chapters.

### Step 3

When the cooking ends, turn the knobs to the off position to turn off the oven.







### HOW TO SET: HEATING FUNCTION





<b>Step 1</b>	Turn the knob for the heating functions to select a heating function.
<b>Step 2</b>	Turn the control knob to select the temperature.

### HEAT-UP INDICATOR

When the oven function operates, the bars in the display  appear one by one when the temperature in the oven increases, and disappear when it decreases.

## HEATING FUNCTIONS

Heating function	Application
 Off position	The oven is off.
 True Fan Cooking	To bake on up to three shelf positions at the same time and to dry food. Set the temperature 20 - 40 °C lower than for Conventional Cooking.
 Conventional Cooking	To bake and roast food on one shelf position.
 Moist Fan Baking	This function is designed to save energy during cooking. When you use this function, the temperature in the cavity may differ from the set temperature. The residual heat is used. The heating power may be reduced. For more information refer to "Daily Use" chapter, Notes on: Moist Fan Baking.
 Fast Grilling	To grill thin pieces of food in large quantities and to toast bread.
 Turbo Grilling	To roast large meat joints or poultry with bones on one shelf position. To make gratins and to brown.

Heating function	Application
 Pizza Function	To bake pizza. To make intensive browning and a crispy bottom.
 Meat	To prepare very tender and juicy roasts.
 Keep Warm	To keep food warm.
 Defrost	To defrost food (vegetables and fruit). The defrosting time depends on the amount and size of the frozen food.
 Pyrolysis	To turn on the pyrolytic cleaning of the oven.

### NOTES ON: MOIST FAN BAKING

This function was used to comply with the energy efficiency class and ecodesign requirements. Tests according to BS EN 60350-1.

The oven door should be closed during cooking so that the function is not interrupted and the oven operates with the highest energy efficiency possible.





When you use this function the lamp automatically turns off after 30 sec.

For the cooking instructions refer to "Hints and tips" chapter, Moist Fan Baking. For general energy saving recommendations refer to "Energy Efficiency" chapter, Energy Saving.

## CLOCK FUNCTIONS



### CLOCK FUNCTIONS TABLE



Clock function	Application
 Time of Day	To show or change the time of day. You can change the time of day only when the oven is off.

Clock function	Application
 Duration	To set the length of cooking. Use only when a heating function is set.
 End Time	To set the oven turn-off time. Use only when a heating function is set.
 Time Delay	Combination of functions: Duration, End Time.
 Minute Minder	To set a countdown time. This function has no effect on the operation of the oven. Minute Minder - can be set at any time, also if the oven is off.





### HOW TO SET: TIME OF DAY

After the first connection to the mains, wait until the display shows: **hr, 12:00. 12** - flashes.

<b>Step 1</b>	Turn the knob for the temperature to set the hour.
<b>Step 2</b>	 - press to confirm. The display shows the set hour and: <b>min. 00</b> - flashes.
<b>Step 3</b>	Turn the knob for the temperature to set the minutes.
<b>Step 4</b>	 - press to confirm. The display shows the set time.

 - press repeatedly to change the time of day.  - flashes in the display.

### HOW TO SET FUNCTION: DURATION

<b>Step 1</b>	Set a heating function.
<b>Step 2</b>	 - press repeatedly.  - starts to flash.
<b>Step 3</b>	Turn the control knob to set the minutes.  - press to confirm.
<b>Step 4</b>	Turn the knob for the temperature to set the hour.  - press to confirm. When the set time ends the signal sounds for 2 min. Time setting flashes in the display. The oven turns off automatically.
<b>Step 5</b>	Press any button to stop the signal.
<b>Step 6</b>	Turn the knobs to the off position.

### HOW TO SET FUNCTION: END TIME

<b>Step 1</b>	Set a heating function.
---------------	-------------------------

<b>Step 2</b>	- press repeatedly.  - starts to flash.
<b>Step 3</b>	Turn the knob for the temperature to set the hour.  - press to confirm.
<b>Step 4</b>	Turn the knob for the temperature to set the minutes.  - press to confirm. At the set end time the signal sounds for 2 min. The time setting flashes in the display. The oven turns off automatically.
<b>Step 5</b>	Press any button to stop the signal.
<b>Step 6</b>	Turn the knobs to the off position.

## HOW TO SET FUNCTION: TIME DELAY

<b>Step 1</b>	Set a heating function.
<b>Step 2</b>	- press repeatedly.  - starts to flash.
<b>Step 3</b>	Turn the knob for the temperature to set the minutes for the function: Duration. Press: .
<b>Step 4</b>	Turn the knob for the temperature to set the hour for the function: Duration. Press: The display shows: .
<b>Step 5</b>	Turn the knob for the temperature to set the hour for the function: End Time. Press: .
<b>Step 6</b>	Turn the knob for the temperature to set the minutes for the function: End Time. Press: .

The display shows: the set temperature, .

Oven turns on automatically later on, works for the set Duration time and stops at the set End Time.  
At the set End Time the signal sounds for 2 min. The time setting flashes in the display. The oven turns off.

<b>Step 7</b>	Press any button to stop the signal.
<b>Step 8</b>	Turn the knobs to the off position.

## HOW TO SET FUNCTION: MINUTE MINDER

Minute minder can be both set when the oven is turned on and off.

<b>Step 1</b>	- press repeatedly. <b>00</b> - flash.
<b>Step 2</b>	Turn the knob for the temperature to set the seconds and then the minutes. When the time you set is longer than 60 min, <b>hr</b> flashes.
<b>Step 3</b>	Set the hours. Minute Minder - starts automatically after 5 sec. After 90% of the set time the signal sounds.

**Step 4**

When the set time ends the signal sounds for 2 min. **00:00**,  - flash. Press any button to stop the signal.

## USING THE ACCESSORIES



**WARNING!** Refer to Safety chapters.

around the shelf prevents cookware from slipping of the shelf.

### INSERTING ACCESSORIES

A small indentation at the top increases safety. The indentations are also anti-tip devices. The high rim

**Wire shelf:**

Push the shelf between the guide bars of the shelf support and make sure that the feet point down.

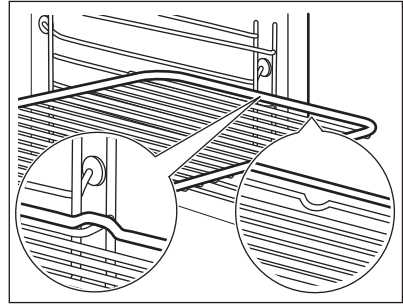

**Deep pan:**

Push the tray between the guide bars of the shelf support.

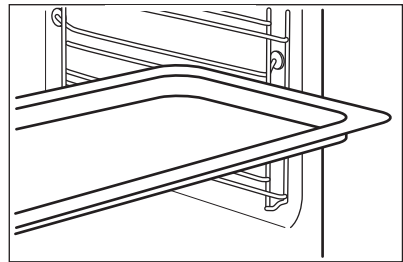

**Wire shelf, Deep pan:**

Push the tray between the guide bars of the shelf support and the wire shelf on the guide bars above.

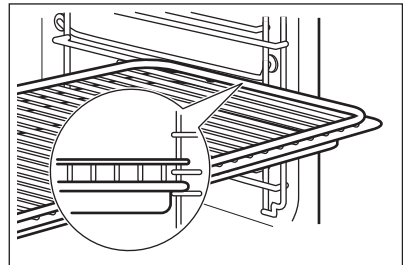

## TRIVET AND GRILL- / ROASTING PAN

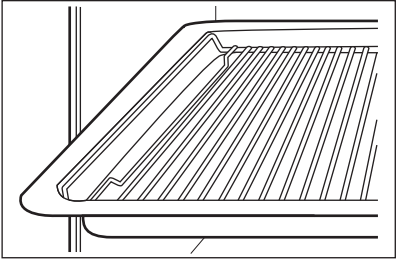
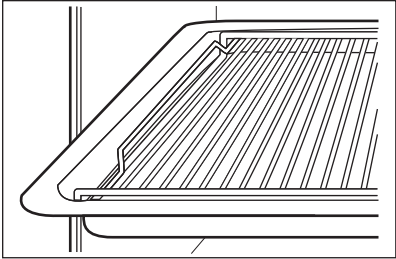
<b>Step 1</b>	Put the trivet into a deep pan.
<b>Step 2</b>	Put the deep pan on the recommended shelf position.
<p><b>Roasting larger pieces of meat or poultry on one shelf position.</b></p> <p>Make sure the supports of the wire shelf point up.</p> 	
<p><b>Grilling and toasting thin pieces of food in large quantities.</b></p> <p>Make sure the supports of the wire shelf point down.</p> 	

## ADDITIONAL FUNCTIONS

### HOW TO USE: CHILD LOCK

When the function is on the oven cannot be turned on accidentally.

<b>Step 1</b>	Ensure the knob for the heating functions is in the off position.
<b>Step 2</b>	 <b>°C</b> - press and hold at the same time for 2 sec.

The signal sounds. **SAFE**,  - appear on the display. The door is locked.

To turn off the Child Lock, repeat the step 2.

### HOW TO USE: FUNCTION LOCK

You can turn on the function only when the oven works. When the function is on the temperature and time settings cannot be changed accidentally.

<b>Step 1</b>	Set an oven function.
<b>Step 2</b>	 <b>°C</b> - press and hold at the same time for 2 sec. The signal sounds. <b>Loc</b> appears on the display for 5 sec.

To turn off the Function Lock, repeat step 2.

**Loc** appears on the display when you turn the control knob or press any button when the Function lock is on. When you turn the knob for the oven functions, the oven stops.

When you turn off the oven while the Function Lock is on, the Function Lock switches automatically to the Child Lock. Refer to "Additional functions" chapter, Using the Child Lock.

### RESIDUAL HEAT INDICATOR

When you turn off the oven, the display shows the residual heat indicator  if the temperature in the oven is more than 40 °C. Turn the knob for the temperature left or right to check the oven temperature.

### AUTOMATIC SWITCH-OFF

For safety reasons the oven turns off after some time, if a heating function works and you do not change any settings.

 (°C)	 (h)
30 - 115	12.5
120 - 195	8.5
200 - 245	5.5
250 - maximum	3

After an automatic switch-off, turn the knobs to the off position.

The Automatic switch-off does not work with the functions: Light, Duration, End Time.

### COOLING FAN

When the oven operates, the cooling fan turns on automatically to keep the surfaces of the oven cool. If you turn off the oven, the cooling fan can continue to operate until the oven cools down.

## HINTS AND TIPS



Refer to Safety chapters.

### COOKING RECOMMENDATIONS

The oven has five shelf positions.

Count the shelf positions from the bottom of the oven floor.

Your oven may bake or roast differently to the oven you had before.

#### Baking cakes

Do not open the oven door before 3/4 of the set cooking time is up.

If you use two baking trays at the same time, keep one empty level between them.

#### Cooking meat and fish

Use a deep pan for very fatty food to prevent the oven from stains that can be permanent.

### SAFETY THERMOSTAT

Incorrect operation of the oven or defective components can cause dangerous overheating. To prevent this, the oven has a safety thermostat which interrupts the power supply. The oven turns on again automatically when the temperature drops.

Leave the meat for approximately 15 minutes before carving so that the juice does not seep out.

To prevent too much smoke in the oven during roasting, add some water into the deep pan. To prevent the smoke condensation, add water each time after it dries up.



#### Cooking times

Cooking times depend on the type of food, its consistency, and volume.

Initially, monitor the performance when you cook. Find the best settings (heat setting, cooking time, etc.) for your cookware, recipes and quantities when you use this appliance.



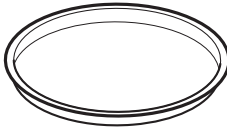
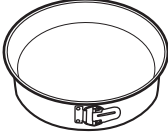

### MOIST FAN BAKING - RECOMMENDED ACCESSORIES

Use the dark and non-reflective tins and containers. They have better heat absorption than the light colour and reflective dishes.





 <p style="text-align: center;"><b>Pizza pan</b></p>	 <p style="text-align: center;"><b>Baking dish</b></p>	 <p style="text-align: center;"><b>Ramekins</b></p>	 <p style="text-align: center;"><b>Flan base tin</b></p>
<p style="text-align: center;">Dark, non-reflective 28 cm diameter</p>	<p style="text-align: center;">Dark, non-reflective 26 cm diameter</p>	<p style="text-align: center;">Ceramic 8 cm diameter, 5 cm height</p>	<p style="text-align: center;">Dark, non-reflective 28 cm diameter</p>

### MOIST FAN BAKING

For the best results follow suggestions listed in the table below.







		 (°C)		 (min)
Sweet rolls, 16 pieces	baking tray or dripping pan	180	2	20 - 30
Rolls, 9 pieces	baking tray or dripping pan	180	2	30 - 40
Pizza, frozen, 0.35 kg	wire shelf	220	2	10 - 15
Swiss roll	baking tray or dripping pan	170	2	25 - 35
Brownie	baking tray or dripping pan	175	3	25 - 30
Soufflé, 6 pieces	ceramic ramekins on wire shelf	200	3	25 - 30
Sponge flan base	flan base tin on wire shelf	180	2	15 - 25
Victoria sandwich	baking dish on wire shelf	170	2	40 - 50
Poached fish, 0.3 kg	baking tray or dripping pan	180	3	20 - 25
Whole fish, 0.2 kg	baking tray or dripping pan	180	3	25 - 35
Fish fillet, 0.3 kg	pizza pan on wire shelf	180	3	25 - 30
Poached meat, 0.25 kg	baking tray or dripping pan	200	3	35 - 45
Shashlik, 0.5 kg	baking tray or dripping pan	200	3	25 - 30
Cookies, 16 pieces	baking tray or dripping pan	180	2	20 - 30
Macaroons, 24 pieces	baking tray or dripping pan	180	2	25 - 35
Muffins, 12 pieces	baking tray or dripping pan	170	2	30 - 40
Savory pastry, 20 pieces	baking tray or dripping pan	180	2	25 - 30
Short crust biscuits, 20 pieces	baking tray or dripping pan	150	2	25 - 35
Tartlets, 8 pieces	baking tray or dripping pan	170	2	20 - 30
Vegetables, poached, 0.4 kg	baking tray or dripping pan	180	3	35 - 45









				
Vegetarian omelette	pizza pan on wire shelf	200	3	25 - 30
Mediterranean vegetables, 0.7 kg	baking tray or dripping pan	180	4	25 - 30

## INFORMATION FOR TEST INSTITUTES

Tests according to IEC 60350-1.

						
Small cakes, 20 per tray	Conventional Cooking	Baking tray	3	170	20 - 30	-
Small cakes, 20 per tray	True Fan Cooking	Baking tray	3	150 - 160	20 - 35	-
Small cakes, 20 per tray	True Fan Cooking	Baking tray	2 and 4	150 - 160	20 - 35	-
Apple pie, 2 tins Ø20 cm	Conventional Cooking	Wire shelf	2	180	70 - 90	-
Apple pie, 2 tins Ø20 cm	True Fan Cooking	Wire shelf	2	160	70 - 90	-
Sponge cake, cake mould Ø26 cm	Conventional Cooking	Wire shelf	2	170	40 - 50	Preheat the oven for 10 minutes.



				 (°C)	 (min)	
Sponge cake, cake mould Ø26 cm	True Fan Cooking	Wire shelf	2	160	40 - 50	Preheat the oven for 10 minutes.
Sponge cake, cake mould Ø26 cm	True Fan Cooking	Wire shelf	2 and 4	160	40 - 60	Preheat the oven for 10 minutes.
Short bread	True Fan Cooking	Baking tray	3	140 - 150	20 - 40	-
Short bread	True Fan Cooking	Baking tray	2 and 4	140 - 150	25 - 45	-
Short bread	Conventional Cooking	Baking tray	3	140 - 150	25 - 45	-
Toast, 4 - 6 pieces	Grill	Wire shelf	4	max.	2 - 3 minutes first side; 2 - 3 minutes second side	Preheat the oven for 3 minutes.
Beef burger, 6 pieces, 0.6 kg	Grill	Wire shelf and dripping pan	4	max.	20 - 30	Put the wire shelf on the fourth level and the dripping pan on the third level of the oven. Turn the food half-way through the cooking time. Preheat the oven for 3 minutes.

## CARE AND CLEANING



**WARNING!** Refer to Safety chapters.

## NOTES ON CLEANING

 <p><b>Cleaning Agents</b></p>	Clean the front of the oven with a soft cloth with warm water and a mild detergent.
	Use a cleaning solution to clean metal surfaces.
	Clean stains with a mild detergent.
 <p><b>Everyday Use</b></p>	Clean the cavity after each use. Fat accumulation or other residue may cause fire.
	Moisture can condense in the oven or on the door glass panels. To decrease the condensation, let the oven work for 10 minutes before cooking. Do not store the food in the oven for longer than 20 minutes. Dry the cavity with a soft cloth after each use.
 <p><b>Accessories</b></p>	Clean all accessories after each use and let them dry. Use a soft cloth with warm water and a mild detergent. Do not clean the accessories in a dishwasher.
	Do not clean the non-stick accessories using abrasive cleaner or sharp-edged objects.

## HOW TO REMOVE: SHELF SUPPORTS

Remove the shelf supports to clean the oven.

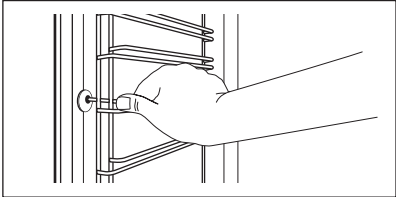
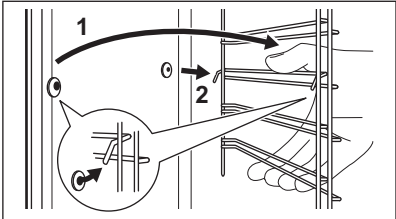
<b>Step 1</b>	Turn off the oven and wait until it is cold.	
<b>Step 2</b>	Pull the front of the shelf support away from the side wall.	
<b>Step 3</b>	Pull the rear end of the shelf support away from the side wall and remove it.	
<b>Step 4</b>	Install the shelf supports in the opposite sequence.	

## HOW TO USE: PYROLYSIS

Clean the oven with Pyrolysis.





**WARNING!** There is a risk of burns.



**CAUTION!** If there are other appliances installed in the same cabinet, do not use them at the same time as this function. It can cause damage to the oven.

### Before the Pyrolysis:

Turn off the oven and wait until it is cold.	Remove all accessories.	Clean the oven floor and the inner door glass with warm water, a soft cloth and a mild detergent.
--	-------------------------	---

**Step 1** Set the function:   - flashes.

**Step 2** Turn the control knob (for the temperature) to set the cleaning mode.

Option	Cleaning mode	Duration
P1	Light cleaning	1 h 30 min
P2	Normal cleaning	2 h 30 min

**Step 3**  - press to start the cleaning.

**Step 4** After cleaning, turn the knob for the heating functions to the off position.

 During the cleaning the oven lamp is off. The oven door stays locked. When the oven is cold, the door unlocks.

When the oven is at the set temperature, the door locks. Until the door unlocks the display shows: the bars of the heat indicator, . To stop cleaning before it is completed, turn the knob for the oven functions to the off position.



### When the cleaning ends:

Turn off the oven and wait until it is cold.	Clean the cavity with a soft cloth.	Remove the residue from the bottom of the cavity.
--	-------------------------------------	---

### CLEANING REMINDER

The oven reminds you when to clean the oven with: pyrolytic cleaning.

PYR - flashes in the display for 10 sec after each activation and deactivation of the oven.



  ,  - press at the same time to turn off the reminder.

### HOW TO REMOVE AND INSTALL: DOOR

The oven door has three glass panels. You can remove the oven door and the internal glass panels to clean them. Read the whole "Removing and installing door" instruction before you remove the glass panels.

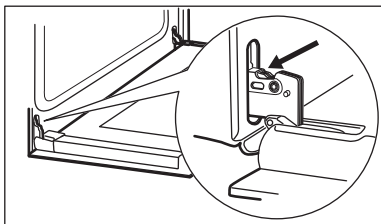
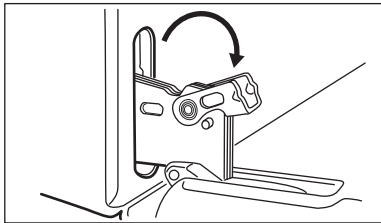

**CAUTION!** Do not use the oven without the glass panels.

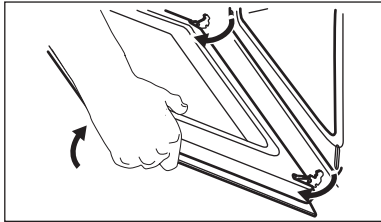
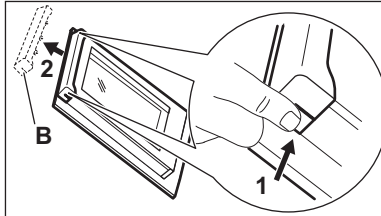
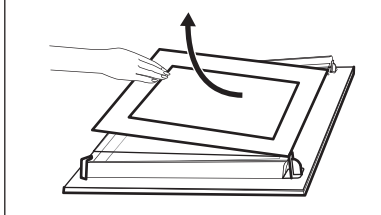
<b>Step 1</b>	Open the door fully and hold both hinges.	
<b>Step 2</b>	Lift and turn the levers fully on both hinges.	
<b>Step 3</b>	Close the oven door halfway to the first opening position. Then lift and pull forward and remove the door from its seat.	
<b>Step 4</b>	Put the door on a soft cloth on a stable surface.	
<b>Step 5</b>	Hold the door trim (B) on the top edge of the door at the two sides and push inwards to release the clip seal.	
<b>Step 6</b>	Pull the door trim to the front to remove it.	
<b>Step 7</b>	Hold the door glass panels by their top edge and carefully pull them out one by one. Start from the top panel. Make sure the glass slides out of the supports completely.	
<b>Step 8</b>	Clean the glass panels with water and soap. Dry the glass panels carefully. Do not clean the glass panels in the dishwasher.	
<b>Step 9</b>	After cleaning, install the glass panels and the oven door.	

Make sure that you put the glass panels (A and B) back in the correct sequence. Check for the symbol / printing on the side of the glass panel, each of the glass panels looks different to make the disassembly and assembly easier. When installed correctly the door trim clicks. Make sure that you install the middle panel of glass in the seats correctly.

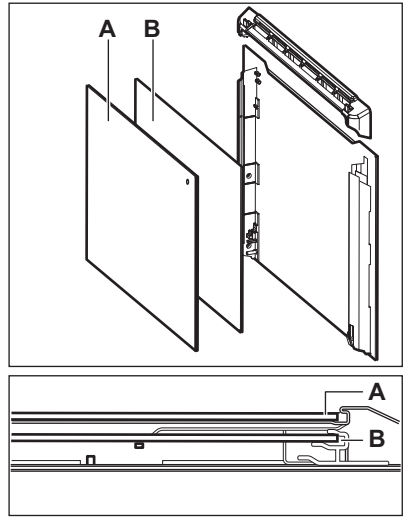

## HOW TO REPLACE: LAMP



**WARNING!** Risk of electric shock.  
The lamp can be hot.

Always hold the halogen lamp with a cloth to prevent grease residue from burning on the lamp.

### Before you replace the lamp:

Step 1	Step 2	Step 3
Turn off the oven. Wait until the oven is cold.	Disconnect the oven from the mains.	Put a cloth on the bottom of the cavity.

### Back lamp

<b>Step 1</b>	Turn the glass cover to remove it.
<b>Step 2</b>	Clean the glass cover.
<b>Step 3</b>	Replace the lamp with a suitable 300 °C heat-resistant lamp.
<b>Step 4</b>	Install the glass cover.

## TROUBLESHOOTING



**WARNING!** Refer to Safety chapters.

### WHAT TO DO IF...

In any cases not included in this table please contact with an Authorised Service Centre.

**The oven does not turn on or does not heat up**

Problem	Check if...
You cannot activate or operate the oven.	The oven is correctly connected to an electrical supply.
The oven does not heat up.	The automatic switch-off is deactivated.
The oven does not heat up.	The oven door is closed.
The oven does not heat up.	The fuse is blown.
The oven does not heat up.	The Child Lock is off.

**Components**

Problem	Check if...
The lamp is turned off.	Moist Fan Baking - is turned on.
The lamp does not work.	The lamp is burnt out.

**Error codes**





The display shows...	Check if...
C3	The oven door is closed or the door lock is not broken.

**Error codes**

F102	The oven door is closed.
F102	The door lock is not broken.
12:00	There was a power cut. Set the time of day.

If the display shows an error code that is not in this table turn the house fuse off and on to restart the oven. If the error code recurs contact an Authorised Service Centre.

**Other problems**

Problem	Check if...
The appliance is activated and does not heat up. The fan does not operate. The display shows "Demo".	<p>The Demo Mode is deactivated:</p> <ol style="list-style-type: none"> <li>Turn off the oven.</li> <li> 3s, ,  - press and hold at the same time.</li> <li>The first digit on the display and Demo flash.</li> <li>Turn the knob for temperature to enter the code: 2468. Press: . The next digit flashes.</li> </ol>

**SERVICE DATA**

If you cannot find a solution to the problem yourself, contact your dealer or an Authorised Service Centre. The necessary data for the service centre is on the rating plate. The rating plate is on the front frame of the oven cavity. Do not remove the rating plate from the oven cavity.

**We recommend that you write the data here:**

Model (MOD.)	.....
Product number (PNC)	.....

**We recommend that you write the data here:**

Serial number (S.N.)

.....

## ENERGY EFFICIENCY

### PRODUCT INFORMATION SHEET ACCORDING TO UK ECODESIGN AND ENERGY LABELLING REGULATIONS

Supplier's name	Zanussi	
Model identification	ZOPNX6K2 949498140 ZOPNX6X2 949498108	
Energy Efficiency Index	81.2	
Energy efficiency class	A+	
Energy consumption with a standard load, conventional mode	0.93 kWh/cycle	
Energy consumption with a standard load, fan-forced mode	0.69 kWh/cycle	
Number of cavities	1	
Heat source	Electricity	
Volume	72 l	
Type of oven	Built-In Oven	
Mass	ZOPNX6K2	32.0 kg
	ZOPNX6X2	32.0 kg

BS EN 60350-1 - Household electric cooking appliances - Part 1: Ranges, ovens, steam ovens and grills - Methods for measuring performance.

### ENERGY SAVING



The oven has features which help you save energy during everyday cooking.

Make sure that the oven door is closed when the oven operates. Do not open the oven door too often during cooking. Keep the door gasket clean and make sure it is well fixed in its position.

Use metal cookware to improve energy saving.

When possible, do not preheat the oven before cooking.

Keep breaks between baking as short as possible when you prepare a few dishes at one time.

#### Cooking with fan

When possible, use the cooking functions with fan to save energy.

### Residual heat

If a programme with the Duration or End Time selection is activated and the cooking time is longer than 30 min, the heating elements automatically turn off earlier in some oven functions.

The fan and lamp continue to operate. When you turn off the oven, the display shows the residual heat. You can use that heat to keep the food warm.

When the cooking duration is longer than 30 min, reduce the oven temperature to minimum 3 - 10 min before the end of cooking. The residual heat inside the oven will continue to cook.

Use the residual heat to warm up other dishes.

#### Keep food warm

Choose the lowest possible temperature setting to use residual heat and keep a meal warm. The residual heat indicator or temperature appears on the display.



### **Cooking with the lamp off**

Turn off the lamp during cooking. Turn it on only when you need it.

### **Moist Fan Baking**

Function designed to save energy during cooking.

When you use this function the lamp automatically turns off after 30 sec. You may turn on the lamp again but this action will reduce the expected energy savings.

## **ENVIRONMENTAL CONCERNS**

---

Recycle materials with the symbol . Put the packaging in relevant containers to recycle it. Help protect the environment and human health by recycling waste of electrical and electronic appliances. Do not dispose of appliances marked

with the symbol  with the household waste. Return the product to your local recycling facility or contact your municipal office.





[WWW.ZANUSSI.COM/SHOP](http://WWW.ZANUSSI.COM/SHOP)



UK  
CA

867359152-D-302021