

# TR4110X-1

|                                        |                   |
|----------------------------------------|-------------------|
| Cooker size                            | 110x60 cm         |
| N. of cavities with energy label       | 2                 |
| Cavity heat source                     | Electric          |
| Hob type                               | Gas               |
| Type of main oven                      | Thermo-ventilated |
| Type of second oven                    | Fan assisted      |
| Cleaning system main oven              | Vapor Clean       |
| EAN code                               | 8017709295066     |
| Energy efficiency class                | A                 |
| Energy efficiency class, second cavity | A                 |



## Aesthetics



|                             |                 |                            |                         |
|-----------------------------|-----------------|----------------------------|-------------------------|
| <b>Aesthetics</b>           | Victoria        | <b>Display</b>             | electronic 5 buttons    |
| <b>Colour</b>               | Stainless steel | <b>Colour of buttons</b>   | Black                   |
| <b>Finishing</b>            | Brushed         | <b>No. of controls</b>     | 12                      |
| <b>Design</b>               | Victoria        | <b>Serigraphy colour</b>   | Black                   |
| <b>Door</b>                 | With frame      | <b>Handle</b>              | Smeg Victoria           |
| <b>Upstand</b>              | Yes             | <b>Handle Colour</b>       | Brushed stainless steel |
| <b>Type of pan stands</b>   | Cast Iron       | <b>Glass type</b>          | Stopsol                 |
| <b>Hob colour</b>           | Black enamel    | <b>Plinth</b>              | Anthracite              |
| <b>Command panel finish</b> | Stainless steel | <b>Storage compartment</b> | Drawer                  |
| <b>Control knobs</b>        | Smeg Victoria   | <b>Logo</b>                | assembled 50's          |
| <b>Controls colour</b>      | Stainless steel | <b>Logo position</b>       | Upstand                 |

## Programs / Functions

No. of cooking functions 5

Traditional cooking functions



Static



Fan assisted



Circulaire



ECO



Fan assisted base

Cleaning functions



Vapor Clean

## Other functions



## Programs / Functions Auxiliary Oven

Cooking functions cavity 2 5

Traditional cooking functions, cavity 2

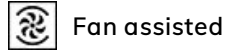

Vapor Clean



Other functions cavity 2

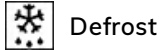

## Programme / Functions Third Oven

No. of functions third oven 1



## Hob technical features



Total no. of cook zones 7

Left - Gas - 2UR (dual) - 4.20 kW

Front left - Gas - AUX - 1.00 kW

Rear left - Gas - Rapid - 2.90 kW

Front centre - Gas - Rapid - 2.90 kW

Rear centre - Gas - AUX - 1.00 kW

Front right - Gas - Semi Rapid - 1.80 kW

Rear right - Gas - Semi Rapid - 1.80 kW

Type of gas burners Standard

Gas safety valves Yes

Automatic electronic ignition Yes

Burner caps Matt black enamelled

## Main Oven Technical Features



No. of lights 1

Removable inner door Yes

Fan number 1

Total no. of door glasses 3

Net volume of the cavity 61 litres

|                                 |                   |                                               |                    |
|---------------------------------|-------------------|-----------------------------------------------|--------------------|
| <b>Gross volume, 1st cavity</b> | 70 l              | <b>No. of thermo-reflective door glasses</b>  | 1                  |
| <b>Cavity material</b>          | Easy clean enamel | <b>Safety Thermostat</b>                      | Yes                |
| <b>Shelf positions</b>          | 4                 | <b>Cooling system</b>                         | Tangential         |
| <b>Type of shelves</b>          | Metal racks       | <b>Usable cavity space dimensions (HxWxD)</b> | 316x460x412 mm     |
| <b>Light type</b>               | Halogen           | <b>Temperature control</b>                    | Electro-mechanical |
| <b>Light power</b>              | 40 W              | <b>Lower heating element power</b>            | 1200 W             |
| <b>Cooking time setting</b>     | Start and Stop    | <b>Upper heating element - Power</b>          | 1000 W             |
| <b>Door opening</b>             | Side opening      | <b>Grill element</b>                          | 1700 W             |
| <b>Side opening door</b>        | Yes               | <b>Large grill - Power</b>                    | 2700 W             |
| <b>Removable door</b>           | Yes               | <b>Circular heating element - Power</b>       | 2700 W             |
| <b>Full glass inner door</b>    | Yes               | <b>Grill type</b>                             | Electric           |

## Options Main Oven

|                                      |     |                            |        |
|--------------------------------------|-----|----------------------------|--------|
| <b>Timer</b>                         | Yes | <b>Minimum Temperature</b> | 50 °C  |
| <b>End of cooking acoustic alarm</b> | Yes | <b>Maximum temperature</b> | 260 °C |

## Second Oven Technical Features



|                                        |                   |                                               |                    |
|----------------------------------------|-------------------|-----------------------------------------------|--------------------|
| <b>Net volume of the second cavity</b> | 61 litres         | <b>No. total door glasses</b>                 | 3                  |
| <b>Gross volume, 2nd cavity</b>        | 70 l              | <b>No. thermo-reflective door glasses</b>     | 1                  |
| <b>Cavity material</b>                 | Easy clean enamel | <b>Safety Thermostat</b>                      | Yes                |
| <b>Shelf positions</b>                 | 4                 | <b>Cooling system</b>                         | Tangential         |
| <b>Type of shelves</b>                 | Metal racks       | <b>Usable cavity space dimensions (HxWxD)</b> | 316x444x425 mm     |
| <b>No. of lights</b>                   | 1                 | <b>Temperature control</b>                    | Electro-mechanical |
| <b>Light type</b>                      | Halogen           | <b>Lower heating element - power</b>          | 1200 W             |
| <b>Light power</b>                     | 40 W              | <b>Upper heating element - Power</b>          | 1000 W             |
| <b>Door opening</b>                    | Side opening      | <b>Grill element - power</b>                  | 1700 W             |
| <b>Side opening door</b>               | Yes               | <b>Large grill - Power</b>                    | 2700 W             |
| <b>Removable door</b>                  | Yes               | <b>Grill type</b>                             | Electric           |
| <b>Full glass inner door</b>           | Yes               |                                               |                    |
| <b>Removable inner door</b>            | Yes               | <b>Tilting grill</b>                          | Yes                |

## Options Auxiliary Oven

|                            |       |                            |        |
|----------------------------|-------|----------------------------|--------|
| <b>Minimum Temperature</b> | 50 °C | <b>Maximum temperature</b> | 260 °C |
|----------------------------|-------|----------------------------|--------|

## Third Oven Technical Features



|                                 |                   |                                               |                    |
|---------------------------------|-------------------|-----------------------------------------------|--------------------|
| <b>Net volume, 3rd cavity</b>   | 36 l              | <b>Removable inner door</b>                   | Yes                |
| <b>Gross volume, 3rd cavity</b> | 41 l              | <b>No. total door glasses</b>                 | 3                  |
| <b>Cavity material</b>          | Easy clean enamel | <b>No. of thermo-reflective door glasses</b>  | 1                  |
| <b>Shelf positions</b>          | 2                 | <b>Safety Thermostat</b>                      | Yes                |
| <b>Type of shelves</b>          | Metal racks       | <b>Cooling system</b>                         | Tangential         |
| <b>No. of lights</b>            | 1                 | <b>Usable cavity space dimensions (HxWxD)</b> | 169x440x443 mm     |
| <b>Light type</b>               | Incandescent      | <b>Temperature control</b>                    | Electro-mechanical |
| <b>Light power</b>              | 25 W              | <b>Large grill - Power</b>                    | 2700 W             |
| <b>Door opening</b>             | Flap down         | <b>Grill type</b>                             | Electric           |
| <b>Removable door</b>           | Yes               | <b>Tilting grill</b>                          | Yes                |
| <b>Full glass inner door</b>    | Yes               |                                               |                    |

## Options Third Oven

|                            |       |                            |        |
|----------------------------|-------|----------------------------|--------|
| <b>Minimum Temperature</b> | 50 °C | <b>Maximum temperature</b> | 260 °C |
|----------------------------|-------|----------------------------|--------|

## Accessories included for Main Oven & Hob



|                                     |   |                                                   |   |
|-------------------------------------|---|---------------------------------------------------|---|
| <b>Cast iron wok support</b>        | 1 | <b>Grill mesh</b>                                 | 1 |
| <b>Rack with back and side stop</b> | 2 | <b>Telescopic Guide rails, partial Extraction</b> | 1 |
| <b>40mm deep tray</b>               | 1 |                                                   |   |

## Accessories included for Secondary Oven



|                                     |   |                                                   |   |
|-------------------------------------|---|---------------------------------------------------|---|
| <b>Rack with back and side stop</b> | 2 | <b>Grill mesh</b>                                 | 1 |
| <b>40mm deep tray</b>               | 1 | <b>Telescopic Guide rails, partial Extraction</b> | 1 |

## Accessories included for Third Oven

|                                     |   |                       |   |
|-------------------------------------|---|-----------------------|---|
| <b>Rack with back and side stop</b> | 1 | <b>40mm deep tray</b> | 1 |
|-------------------------------------|---|-----------------------|---|

## Electrical Connection

|                                         |                   |                               |                             |
|-----------------------------------------|-------------------|-------------------------------|-----------------------------|
| <b>Max Power Draw</b>                   | 8400 W            | <b>Cable testing</b>          | Yes                         |
| <b>Current</b>                          | 37 A              | <b>Type of electric cable</b> | Yes, Double and Three Phase |
| <b>Voltage</b>                          | 220-240 V         | <b>Frequency</b>              | 50/60 Hz                    |
| <b>Voltage 2 (V)</b>                    | 380-415 V         | <b>Terminal block</b>         | 5 poles                     |
| <b>Type of electric cable installed</b> | Yes, Single phase |                               |                             |

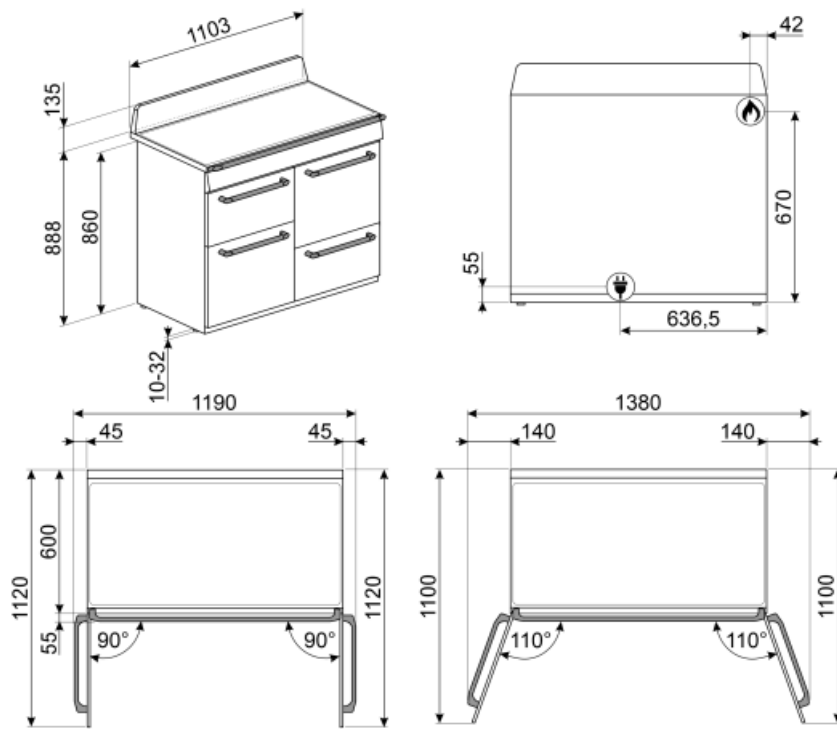

## Not included accessories



### KITH4110

Height extension kit (950 mm), suitable for TR4110 cookers



### GTP

\*\*Partially extractable telescopic guides (1 level)\*\* Extraction: 300 mm Material: Stainless steel AISI 430 polished



### BNP608T

Teflon-coated tray, 8mm depth, to be placed on the grid



### WOKGHU

Cast-Iron WOK Support



### BN620-1

Enamelled tray, 20mm deep



### KIT600TR4110

Cover strip for hob back side, suitable for TR4110 Victoria cookers



### BBQ

Double sided plate BBQ. Suitable for recreating succulent and crispy dishes in the oven with the typical taste of grilled cooking. The ribbed side is particularly suitable for meats and cheeses. The smooth side for fish, seafood and vegetables.



### GTT

\*\*Totally extractable telescopic guides (1 level)\*\* Extraction: 433 mm Material: Stainless steel AISI 430 polished

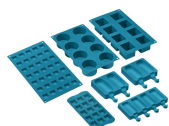

### SMOLD

Set of 7 silicone moulds for ice creams, ice lollies, pralines, ice cubes or to portion food. Usable from -60°C to +230°C



### AIRFRY

Air fryer rack AIRFRY . Ideal for recreating traditional frying in the oven, but with fewer calories and less fat. It allows you to cook quickly and simply dishes such as French fries, fried vegetables and fish, ensuring perfect browning and crispiness.



### PRTX

Refractory pizza stone with handles. D=35cm Not suitable for microwave ovens. Suitable for gas ovens, to be put on the griddle.



### TPKTR

Teppanyaki grill plate for TR4110 cookers



### KIT1TR41N

Splashback 110x75 cm suitable for TR4110 Victoria cookers, black



### KITP65TR41

Depth extension kit (650 mm), suitable for TR4110 cookers



### BGTR4110

Cast iron grill plate suitable for Victoria Cookers TR4110



### PALPZ

























Pizza shovel with fold away handle width: 315mm length : 325mm



### BN640

Enamelled tray, 40mm deep

## Symbols glossary

|                                                                                                                                                                                                                                                                                                                                                                                                                                                            |                                                                                                                                                                                                                                                                                                                                                                                                                            |
|------------------------------------------------------------------------------------------------------------------------------------------------------------------------------------------------------------------------------------------------------------------------------------------------------------------------------------------------------------------------------------------------------------------------------------------------------------|----------------------------------------------------------------------------------------------------------------------------------------------------------------------------------------------------------------------------------------------------------------------------------------------------------------------------------------------------------------------------------------------------------------------------|
|  <p>Heavy duty cast iron pan stands: for maximum stability and strength.</p>                                                                                                                                                                                                                                                                                               |  <p>Air cooling system: to ensure a safe surface temperatures.</p>                                                                                                                                                                                                                                                                        |
|  <p>With the switch on this symbol, no heating is possible even if the thermostat is turned.</p>                                                                                                                                                                                                                                                                           |  <p>Triple glazed doors: Number of glazed doors.</p>                                                                                                                                                                                                                                                                                      |
|  <p>A: Product drying performance, measured from A+++ to D / G depending on the product family</p>                                                                                                                                                                                                                                                                         |  <p>Enamel interior: The enamel interior of all Smeg ovens have a special antacid lining which helps keep the interior clean by reducing the amount of cooking grease adhering to it.</p>                                                                                                                                                 |
|  <p>Circogas: In gas ovens the fan distributes the heat quickly and evenly throughout the oven cavity, avoiding flavour transfer when cooking a number of different dishes at the same time. In electric ovens this combination completes cooking more quickly of foods that are ready on the surface, but that require more cooking inside, without further browning.</p> |  <p>Fan with upper and lower elements: The elements combined with the fan aim to provide more uniform heat, a similar method to conventional cooking, so pre-heat is required. Most suitable for items requiring slow cooking methods.</p>                                                                                                |
|  <p>Upper and lower element only: a traditional cooking method best suited for single items located in the centre of the oven. the top pf the oven will always be hottest. Ideal for roast, fruit cakes, bread etc.</p>                                                                                                                                                   |  <p>Circulaire: The combination of the fan and circular element around it gives a hot air cooking method. This provides many benefits including no preheat if cook time is more than 20 minutes, no flavour transfer when cooking different foods at the same time, less energy, and shorter cook times. Good for all types of food.</p> |
|  <p>ECO: The combination of the grill, fan and lower element is particularly suitable for cooking small quantities of food.</p>                                                                                                                                                                                                                                          |  <p>Grill element: Using of grill gives excellent results when cooking meat of medium and small portions, especially when combined with a rotisserie (where possible). Also ideal for cooking sausages and bacon.</p>                                                                                                                   |
|  <p>Light</p>                                                                                                                                                                                                                                                                                                                                                            |  <p>All glass inner door: All glass inner door, a single flat surface which is simple to keep clean.</p>                                                                                                                                                                                                                                |
|  <p>The inner door glass: can be removed with a few quick movements for cleaning.</p>                                                                                                                                                                                                                                                                                    |  <p>Side lights: Two opposing side lights increase visibility inside the oven.</p>                                                                                                                                                                                                                                                      |
|  <p>The oven cavity has 2 different cooking levels.</p>                                                                                                                                                                                                                                                                                                                  |  <p>The oven cavity has 4 different cooking levels.</p>                                                                                                                                                                                                                                                                                 |
|  <p>Telescopic rails: allow you to pull out the dish and check it without having to remove it from the oven entirely.</p>                                                                                                                                                                                                                                                |  <p>Electronic control: Allows you to maintain temperature inside the oven with the precision 2-3 ° C. This enables to cook meals that are very sensitive to temperature changes, such as cakes, souffles, puddings.</p>                                                                                                                |
|  <p>Tilting grill: the tilting grill can be easily unhooked to move the heating element and clean the roof of the appliance in one simple step.</p>                                                                                                                                                                                                                      |  <p>Ultra rapid burners: Powerful ultra rapid burners offer up to 5kw of power.</p>                                                                                                                                                                                                                                                     |
|  <p>Vapor Clean: a simple cleaning function using steam to loosen deposits in the oven cavity.</p>                                                                                                                                                                                                                                                                       |  <p>The capacity indicates the amount of usable space in the oven cavity in litres.</p>                                                                                                                                                                                                                                                 |



The capacity indicates the amount of usable space in the oven cavity in litres.