

# SFP6301TVN



Category	60cm
Product Family	Oven
Power supply	Electric
Heat source	Electric
Cooking method	Thermo-ventilated
Cleaning system	Pyrolytic
EAN code	8017709310233



## Aesthetics

Aesthetics	Classic	Serigraphy type	Symbols
Colour	Black	Door	With 2 horizontal strips
Finishing	Matte	Handle	Classic
Design	Flat	Handle Colour	All black special edition
Material	Painted material	Logo	Silk screen
Glass Type	Eclipse	Control knobs	Classic
Serigraphy colour	Silver	Controls colour	Matt black

## Controls

			
Display name	CompactScreen	Control setting	Control knobs
Display technology	LCD	No. of controls	2

## Programs / Functions

No. of cooking functions	10
--------------------------	----

### Traditional cooking functions

- Static
- Fan assisted
- Circulaire
- Turbo (circulaire + bottom + upper + fan)
- ECO
- Large grill
- Fan grill (large)
- Base
- Circulaire + bottom
- Pizza

### Other functions

- Defrost by time
- Proving
- Sabbath

### Cleaning functions

- Pyrolytic

## Options



- Time-setting options** Delay start and automatic end cooking
- Minute minder** Yes
- Timer** 1
- Controls Lock / Child Safety** Yes

- Other options** Keep warm
- Showroom demo option** Yes
- Rapid pre-heating** Yes

## Technical Features



- |                                  |         |                                       |            |
|----------------------------------|---------|---------------------------------------|------------|
| <b>Minimum Temperature</b>       | 30 °C   | <b>Door</b>                           | Cool       |
| <b>Maximum temperature</b>       | 280 °C  | <b>Removable door</b>                 | Yes        |
| <b>Shelf positions</b>           | 5       | <b>Full glass inner door</b>          | Yes        |
| <b>No. of lights</b>             | 1       | <b>Removable inner door</b>           | Yes        |
| <b>Light type</b>                | Halogen | <b>Total no. of door glasses</b>      | 4          |
| <b>User-replaceable light</b>    | Yes     | <b>Cooling system</b>                 | Tangential |
| <b>Light power</b>               | 40 W    | <b>Cooling duct</b>                   | Double     |
| <b>Light when door is opened</b> | Yes     | <b>Speed Reduction Cooling System</b> | Yes        |

Lower heating element power	1200 W	Door Lock During Pyrolysis	Yes
Grill element - power	1800 W	Usable cavity space dimensions (HxWxD)	360x444x425 mm
Circular heating element - Power	2000 W	Temperature control	Electronic
Heating suspended when door is opened	Yes	Cavity material	Easy clean enamel
Door opening type	Standard opening		

## Performance / Energy Label



Energy efficiency class	A+	Energy consumption in forced air convection	2.45 MJ
Net volume of the cavity	70 litres	Energy consumption per cycle in fan-forced convection	0.68 kWh
Energy consumption per cycle in conventional mode	1.09 kWh	Number of cavities	1
Energy consumption in conventional mode	3.92 MJ	Energy efficiency index	81 %

## Accessories Included

Chrome shelf with back and side stop	1	Grill mesh	1
Extra deep enamelled tray (40mm)	1		

## Electrical Connection

Voltage	220-240 V	Frequency (Hz)	50/60 Hz
Current	13 A	Power supply cable length	150 cm
Nominal power (W)	3000 W		

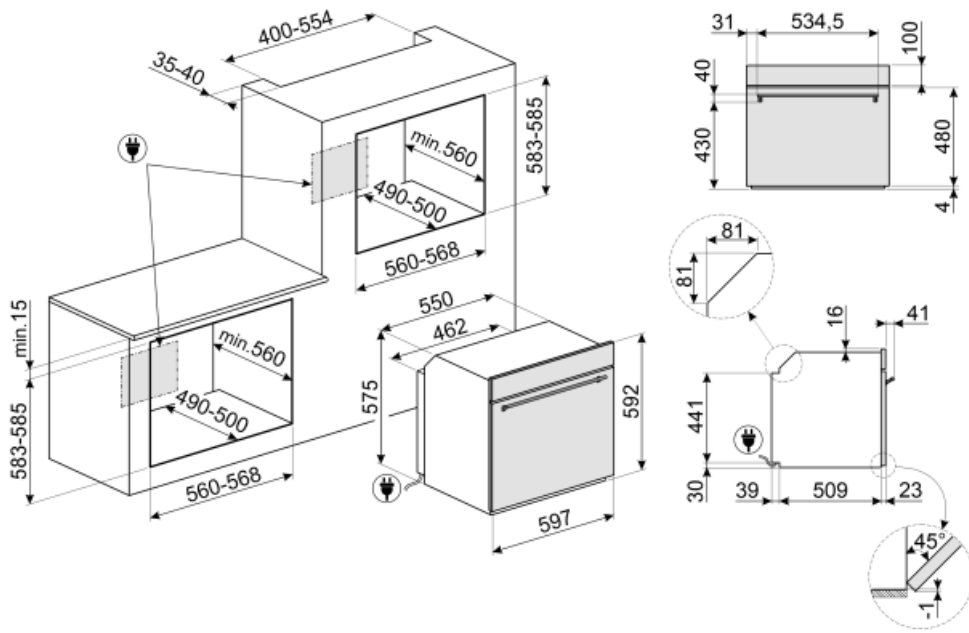

---

## Not included accessories

---



### PR3845N

Black spacer cover for furniture when more ovens are installed in column. Suitable for 45cm Dolce Stil Novo compact ovens.



### PRTX

Refractory pizza stone with handles. D=35cm Not suitable for microwave ovens. Suitable for gas ovens, to be put on the griddle.



### PALPZ

Pizza shovel with fold away handle width: 315mm length : 325mm



### BN640

Enamelled tray, 40mm deep



### GTP

\*\*Partially extractable telescopic guides (1 level)\*\* Extraction: 300 mm Material: Stainless steel AISI 430 polished



### BN620-1



















Enamelled tray, 20mm deep















### GTT

\*\*Totally extractable telescopic guides (1 level)\*\* Extraction: 433 mm Material: Stainless steel AISI 430 polished

## Symbols glossary

 <p>Child lock: some models are fitted with a device to lock the programme/cycle so it cannot be accidentally changed.</p>	 <p>Air cooling system: to ensure a safe surface temperatures.</p>
 <p>Defrost by time: with this function the time of thawing of foods are determined automatically.</p>	 <p>...</p>
 <p>Quadruple glazed: Number of glazed doors.</p>	 <p>Electric</p>
 <p>A+: Energy efficiency class A+ helps to save up to 10% energy compared to class A. Maximum performance with minimum consumption is guaranteed.</p>	 <p>Enamel interior: The enamel interior of all Smeg ovens have a special antacid lining which helps keep the interior clean by reducing the amount of cooking grease adhering to it.</p>
 <p>Fresh Touch: Most of Smeg ovens have a "cool door." Thanks to the combination of tangential cooling and internal heat-reflecting glasses, the temperature on the outer surface of the door is maintained below 50° C. In addition to providing safety, this system protects the sides of the furniture from overheating by the oven.</p>	 <p>Fan with upper and lower elements: The elements combined with the fan aim to provide more uniform heat, a similar method to conventional cooking, so pre-heat is required. Most suitable for items requiring slow cooking methods.</p>
 <p>Upper and lower element only: a traditional cooking method best suited for single items located in the centre of the oven. the top pf the oven will always be hottest. Ideal for roast, fruit cakes, bread etc.</p>	 <p>Lower heating element only: This function is ideal for foods that require extra base temperature without browning, e.g. pastry dishes, pizza. Also suitable for slow cooking of stews and casseroles.</p>
 <p>Circulaire with lower element: The addition of the lower element adds extra heat at the base for food which requires extra cooking.</p>	 <p>Circulaire: The combination of the fan and circular element around it gives a hot air cooking method. This provides many benefits including no preheat if cook time is more than 20 minutes, no flavour transfer when cooking different foods at the same time, less energy, and shorter cook times. Good for all types of food.</p>
 <p>ECO: The combination of the grill, fan and lower element is particularly suitable for cooking small quantities of food.</p>	 <p>Grill element: Using of grill gives excellent results when cooking meat of medium and small portions, especially when combined with a rotisserie (where possible). Also ideal for cooking sausages and bacon.</p>
 <p>Fan with grill element: The fan reduces the fierce heat from the grill, providing an excellent method of grilling various foods, chops, steaks, sausages etc. giving even browning and heat distribution, without drying out the food. The top two levels recommended for use, and the lower part of the oven can be used to keep items warm at the same time, an excellent facility when cooking a grilled breakfast. Half grill (centre portion only) is ideal for small quantities of food.</p>	 <p>Pizza function: The simultaneous operation of three elements ensures an optimum cooking facility when used with the Smeg pizza stone.</p>

- 
- |   |  |
|---|--|
|  <p><b>Circulaire with upper and lower elements:</b> The use of the fan with both elements allows food to be cooked quickly and effectively, ideal for large joints that require thorough cooking. It offers a similar result to rotisserie, moving the heat around the food, instead of moving the food itself, enabling any size or shape to be cooked.</p> |  <p><b>All glass inner door:</b> All glass inner door, a single flat surface which is simple to keep clean.</p>               |
|  <p><b>The inner door glass:</b> can be removed with a few quick movements for cleaning.</p>  |  <p><b>Keep warm:</b> This function allows you to keep precooked foods warm.</p>  |
|  <p><b>Side lights:</b> Two opposing side lights increase visibility inside the oven.</p>   |  <p><b>Pyrolitic:</b> Pyrolitic cleaning cycles can be selected as necessary to automatically clean the oven interior.</p>    |
|  <p><b>Air at 40°C</b> provides the perfect environment for proving yeast type dough mixes. Simply select the function and place dough in the cavity for allotted</p>   |  <p><b>Rapid preheat:</b> The rapid preheat function can be used to reach the selected temperature in just a few minutes.</p> |
|  <p><b>Sabbath:</b> This function allows you to cook food whilst respecting the provisions of the Jewish day of rest.</p>   |  <p>The oven cavity has 5 different cooking levels.</p>   |
|  <p><b>Electronic control:</b> Allows you to maintain temperature inside the oven with the precision 2-3 ° C. This enables to cook meals that are very sensitive to temperature changes, such as cakes, souffles, puddings.</p>  |  <p>The capacity indicates the amount of usable space in the oven cavity in litres.</p>                                      |