

KBT600XE

Product family	Hood
Hood Type	Decorative wall hood
Design	T flat
Extraction	Ducted out or re-circulation possible
Electronic control	Yes
Material	Stainless steel
Type of steel	Brushed
EAN code	8017709286613
Hood width	60 cm





Aesthetics

Aesthetics	Universal	Finishing	Brushed
Colour	Stainless steel	Logo	Silk screen



Controls

Control setting	Electronic buttons
-----------------	--------------------

Programs / Functions

No. of speeds	3
Intensive speed	
24h air filter function	
Time-setting options	

Technical Features

  	No. of lights	2	Anti-grease filters	Aluminium
	Light type	LED	Filter replacement indicator	Yes
	Light power	1,3 W	Vent outlet	150 mm
	Light color temperature scale (°K)	3000 °K	Minimum distance from GAS hob	650 mm

Free outlet maximum capacity	820 m ³ /h	Minimum distance from ELECTRIC hob	500 mm
Motor power	230 W	Non return valve	Yes
No. of filters	2		

	Extraction rate IEC 61591 [m ³ /h]	Noise level IEC 60704-2-13 [dB(A)]
Speed 1	260	49
Speed 2	358	57
Speed 3	473	64
Intensive speed	686	72

Accessories Included

Tube reduction	Yes
----------------	-----

Performance / Energy Label

A			
Annual Efficiency Consumption (AEC _{hood})	53 KWh/year	Airborne acoustical A-weighted sound Power Emission at maximum speed (SPE _{max})	64 dB(A)
Energy efficiency class (EEC)	A	Airbourne acoustical A-weighted sound power emission at boost speed (SPE _{boost})	71 dB(A)
Fluid Dynamic Efficiency (FDE)	29.8	Power Consumption in Off mode (P _o)	0.49 W
Fluid Dynamic Efficiency class (FDEC)	A	Power consumption in stand-by mode (P _s)	0.23 W
Lighting Efficiency (LE)	70.4 lux/W	Time increase factor (F)	0.9
Lighting Efficiency Class (LEC)	A	Energy Efficiency Index per first cavity	52.0
Grease Filtering Efficiency (GFE)	79.7 %	Measured air flow rate at best efficiency point (Q _{bep})	395 m ³ /h
Grease Filtering Efficiency Class (GFEC)	C	Measured air pressure at best efficiency point (Q _{bep})	451 Pa
Air flow at mininum speed (Q _{min})	261 m ³ /h	Measured electric power input at best efficiency point (W _{bep})	159 W
Maximum extraction rate	473 m ³ /h	Normal Power of the light system (W _l)	3 W
Intensive extraction rate	686 m ³ /h	Average illumination of the light on the cooking surface (E _{middle})	156 lux
Airbourne acouistical A-weighted sound Power Emission at minimum speed (SPE _{min})	48 dB(A)		

Sound power level at highest setting (Lwa) 70 dB(A)

Electrical Connection

Nominal power	230 W	Frequency (Hz)	50-60 Hz
Voltage	220-240 V	Power supply cable length	1500 mm

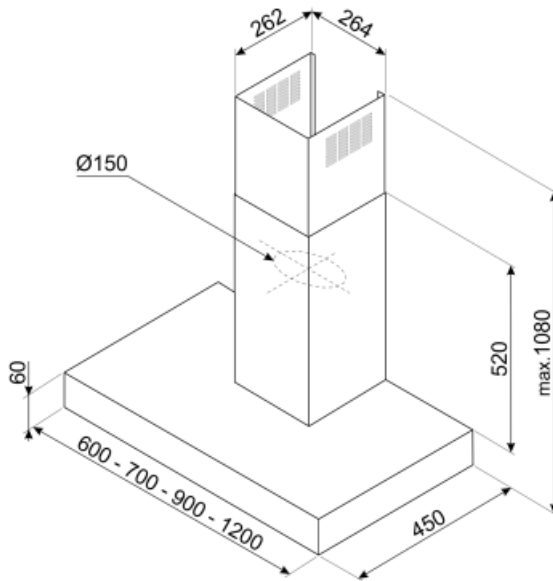

Not included accessories

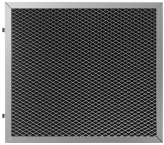

KITFCKBT

1 pcs of activated carbon filter for hood models KBT* / KBCT*



KITCEKBT



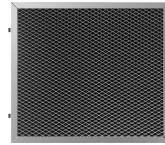



Chimney extension, dimensions 261,5 * 260 * 830 mm suitable for T-shape hood KBT* & KBCT*, max hight 1380 mm Stainless Steel



KITFCKBTR

1 pcs of Charcoal filter Regenerable* suitable for all the KBT/KBCT models.
* It can be washed in the dishwasher up to 12 times and dry in the oven at max 90° for 60 min. dimension 237,5(H)x245x10 mm

Symbols glossary

- | | | | |
|--|---|---|--|
|  | 24h: When selected this function refreshes the air for c. 10 minutes every hour over a 24 hour period, at minimum speed and an imperceptible noise level. |  | A: Product drying performance, measured from A+++ to D / G depending on the product family |
|  | Filters: Model has filters to help remove grease from the steam emanating from the pans during cooking. |  | Switch off automatically: A special setting, to run after the end of cooking for a pre-set time and then switch off automatically. |
|  | Warning light(s): to advise when filters need changing. |  | Lights: All cooker hoods feature lights to illuminate the cooking area or add to the ambience of the kitchen. |
|  | Intensive/turbo setting: when extra fast extraction is required. | | |