

# C6IPBLT2

Cooker size	60x60 cm
N. of cavities with energy label	1
Cavity heat source	Electric
Hob type	Induction
Type of main oven	Thermo-ventilated
Cleaning system main oven	Pyrolytic
EAN code	8017709332587
Energy efficiency class	A



## Aesthetics



<b>Aesthetics</b>	Classic	<b>Display</b>	Touch
<b>Series</b>	Concert	<b>No. of controls</b>	2
<b>Colour</b>	Black	<b>Serigraphy colour</b>	Silver
<b>Finishing</b>	Gloss	<b>Type of control setting</b>	Touch control
<b>Design</b>	Standard	<b>Slider</b>	Red
<b>Door</b>	Full glass	<b>Handle</b>	Smeg Classic
<b>Upstand</b>	Yes	<b>Handle Colour</b>	Brushed stainless steel
<b>Hob colour</b>	Stainless steel	<b>Glass type</b>	dark grey
<b>Command panel finish</b>	Enamelled metal	<b>Feet</b>	Black
<b>Control knobs</b>	Smeg Classic	<b>Logo</b>	Silk screen
<b>Controls colour</b>	Stainless steel	<b>Logo position</b>	Facia below the oven

## Programs / Functions

No. of cooking functions	9
--------------------------	---

### Traditional cooking functions

- Static
- Fan assisted
- Circulaire
- Turbo (circulaire + bottom + upper + fan)
- ECO
- Small grill
- Large grill
- Fan grill (large)
- Fan assisted base

### Cleaning functions

- Pyrolytic

### Hob options



<b>Control lock</b>	Yes	<b>Limited Power Consumption Mode</b>	Yes
<b>End cooking timer</b>	4	<b>Limited Power Consumption Mode in W</b>	1000, 1600, 2200, 2800, 3500, 6000, 7200 W
<b>Minute minder</b>	1	<b>Bridge option</b>	Yes

### Hob technical features



**Total no. of cook zones** 4

- Front left - Induction - single - 1.50 kW - Booster 2.00 kW - - Ø 18.0 cm
- Rear left - Induction - single - 1.50 kW - Booster 2.00 kW - - Ø 18.0 cm
- Rear right - Induction - single - 1.50 kW - Booster 2.00 kW - - Ø 18.0 cm
- Front right - Induction - single - 1.50 kW - Booster 2.00 kW - - Ø 18.0 cm

<b>Automatic switch off when overheat</b>	Yes	<b>Selected zone indicator</b>	Yes
<b>Automatic pan detection</b>	Yes	<b>Residual heat indicator</b>	Yes
<b>Minimum pan diameter indication</b>	Yes		

### Main Oven Technical Features



<b>No. of lights</b>	1	<b>Removable inner door</b>	Yes
<b>Fan number</b>	1	<b>Total no. of door glasses</b>	4
<b>Net volume of the cavity</b>	70 litres		

<b>Gross volume, 1st cavity</b>	79 l	<b>No. of thermo-reflective door glasses</b>	3
<b>Cavity material</b>	Easy clean enamel	<b>Safety Thermostat</b>	Yes
<b>Shelf positions</b>	5	<b>Heating suspended when door is opened</b>	Yes
<b>Type of shelves</b>	Metal racks	<b>Cooling system</b>	Tangential
<b>Light type</b>	Halogen	<b>Door Lock During Pyrolysis</b>	Yes
<b>Light power</b>	40 W	<b>Usable cavity space dimensions (HxWxD)</b>	360X460X425 mm
<b>Cooking time setting</b>	Start and Stop	<b>Temperature control</b>	Electro-mechanical
<b>Light when oven door is open</b>	Yes	<b>Lower heating element power</b>	1200 W
<b>Door opening</b>	Flap down	<b>Upper heating element - Power</b>	1000 W
<b>Removable door</b>	Yes	<b>Large grill - Power</b>	2700 W
<b>Full glass inner door</b>	Yes	<b>Circular heating element - Power</b>	2000 W
		<b>Grill type</b>	Electric

## Options Main Oven

<b>Timer</b>	Yes	<b>Minimum Temperature</b>	50 °C
<b>End of cooking acoustic alarm</b>	Yes	<b>Maximum temperature</b>	280 °C

## Accessories included for Main Oven & Hob



<b>Rack with back and side stop</b>	2	<b>Grill mesh</b>	1
<b>40mm deep tray</b>	1	<b>Telescopic Guide rails, partial Extraction</b>	1

## Electrical Connection

<b>Max Power Draw</b>	10000 W	<b>Type of electric cable installed</b>	Yes, Single phase
<b>Current</b>	44 A	<b>Type of electric cable</b>	Yes, Double and Three Phase
<b>Voltage</b>	220-240 V	<b>Frequency</b>	50/60 Hz
<b>Voltage 2 (V)</b>	380-415 V	<b>Terminal block</b>	5 poles

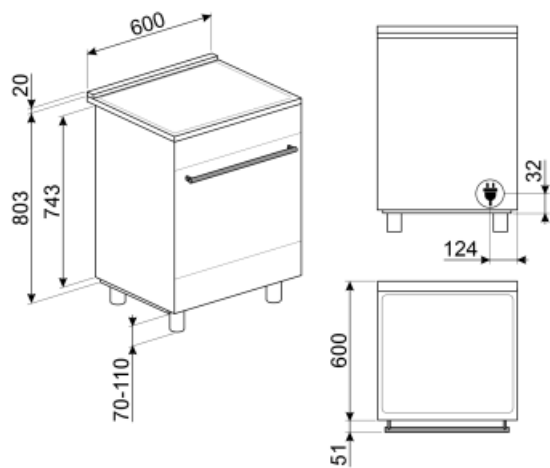

## Not included accessories

### AIRFRY

Air fryer rack AIRFRY . Ideal for recreating traditional frying in the oven, but with fewer calories and less fat. It allows you to cook quickly and simply dishes such as French fries, fried vegetables and fish, ensuring perfect browning and crispiness.



### GTP

\*\*Partially extractable telescopic guides (1 level)\*\* Extraction: 300 mm Material: Stainless steel AISI 430 polished



### BNP608T

Teflon-coated tray, 8mm depth, to be placed on the grid



### KITPBX

Height reduction feet (850 mm)



### BN620-1

Enamelled tray, 20mm deep



### BBQ

Double sided plate BBQ. Suitable for recreating succulent and crispy dishes in the oven with the typical taste of grilled cooking. The ribbed side is particularly suitable for meats and cheeses. The smooth side for fish, seafood and vegetables.



### TPKPLATE

Universal plate for induction, gas, ceramic and electric hobs. Non-stick surface ideal for cooking fish, eggs and vegetables. Dimensions: 410 X 240 mm.



### SFLK1

Child lock



### PRTX

Refractory pizza stone with handles. D=35cm Not suitable for microwave ovens. Suitable for gas ovens, to be put on the griddle.



### GRILLPLATE

Universal griddle for induction, gas, ceramic and electric hobs. Non-stick surface ideal for cooking meat, cheese and vegetables. Dimensions: 410 x 240 mm.



### KITC6X

Splashback, 60x75 cm, stainless steel, suitable for Symphony cookers

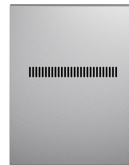

### SCRP

Induction and ceramic hobs and teppanyaki scraper



### STONE

Rectangular refractory stone. Ideal for cooking pizzas with the same results as a typical wood-fired oven. Can also be used for baking bread, focaccias and other recipes such as pies, flans or biscuits. Dimensions: L42 x H1,8 x P37,5 cm.



### PALPZ

Pizza shovel with fold away handle width: 315mm length : 325mm





### KITP60X9

Splashback, 90 cm, stainless steel,  
suitable for pyrolytic Concert cookers



### GTT

\*\*Totally extractable telescopic  
guides (1 level)\*\* Extraction: 433 mm  
Material: Stainless steel AISI 430  
polished



### BN640



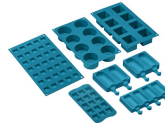















Enamelled tray, 40mm deep













### SMOLD

Set of 7 silicone moulds for ice creams,  
ice lollies, pralines, ice cubes or to  
portion food. Usable from -60°C to  
+230°C

## Symbols glossary

 <p>Child lock: some models are fitted with a device to lock the programme/cycle so it cannot be accidentally changed.</p>	 <p>Touch control</p>
 <p>Air cooling system: to ensure a safe surface temperatures.</p>	 <p>Quadruple glazed: Number of glazed doors.</p>
 <p>ECO-logic: option allows you to restrict the power limit of the appliance real energy saving.</p>	 <p>A: Product drying performance, measured from A+++ to D / G depending on the product family</p>
 <p>Enamel interior: The enamel interior of all Smeg ovens have a special antacid lining which helps keep the interior clean by reducing the amount of cooking grease adhering to it.</p>	 <p>Circogas: In gas ovens the fan distributes the heat quickly and evenly throughout the oven cavity, avoiding flavour transfer when cooking a number of different dishes at the same time. In electric ovens this combination completes cooking more quickly of foods that are ready on the surface, but that require more cooking inside, without further browning.</p>
 <p>Fan with upper and lower elements: The elements combined with the fan aim to provide more uniform heat, a similar method to conventional cooking, so pre-heat is required. Most suitable for items requiring slow cooking methods.</p>	 <p>Upper and lower element only: a traditional cooking method best suited for single items located in the centre of the oven. the top pf the oven will always be hottest. Ideal for roast, fruit cakes, bread etc.</p>
 <p>Circulaire: The combination of the fan and circular element around it gives a hot air cooking method. This provides many benefits including no preheat if cook time is more than 20 minutes, no flavour transfer when cooking different foods at the same time, less energy, and shorter cook times. Good for all types of food.</p>	 <p>ECO: The combination of the grill, fan and lower element is particularly suitable for cooking small quantities of food.</p>
 <p>Grill element: Using of grill gives excellent results when cooking meat of medium and small portions, especially when combined with a rotisserie (where possible). Also ideal for cooking sausages and bacon.</p>	 <p>Half grill: For rapid cooking and browning of foods. Best results can be obtained by using the top shelf for small items, the lower shelves for larger ones, such as chops or sausages. For half grill heat is generated only at the centre of the element, so is ideal for smaller quantities.</p>
 <p>Fan with grill element: The fan reduces the fierce heat from the grill, providing an excellent method of grilling various foods, chops, steaks, sausages etc. giving even browning and heat distribution, without drying out the food. The top two levels recommended for use, and the lower part of the oven can be used to keep items warm at the same time, an excellent facility when cooking a grilled breakfast. Half grill (centre portion only) is ideal for small quantities of food.</p>	 <p>Circulaire with upper and lower elements: The use of the fan with both elements allows food to be cooked quickly and effectively, ideal for large joints that require thorough cooking. It offers a similar result to rotisserie, moving the heat around the food, instead of moving the food itself, enabling any size or shape to be cooked.</p>
 <p>Overheat protection: The safety system that automatically turns off the hob in case of overheating of the control unit.</p>	 <p>Induction: The work of these hobs is based on the principle of electromagnetic induction. The heat is generated directly in the bottom of the pan during its contact with the hob.</p>

- 
- |  |   |   |   |
|--|---|---|---|
|  | All glass inner door: All glass inner door, a single flat surface which is simple to keep clean.  |  | The inner door glass: can be removed with a few quick movements for cleaning.                               |
|  | Side lights: Two opposing side lights increase visibility inside the oven.  |  | Pyrolytic: Pyrolytic cleaning cycles can be selected as necessary to automatically clean the oven interior. |
|  | Indication of residual heat: After the glass ceramic hob is switched off the residual heat indicator shows which of the heating zones still remains hot. When the temperature drops below 60 ° C, the indicator goes out. |  | The oven cavity has 5 different cooking levels.   |
|  | Telescopic rails: allow you to pull out the dish and check it without having to remove it from the oven entirely.   |  | Timer: All ceramic hobs have a timer which automatically ends cooking after a preset time.                  |
|  | TWIN_ZONE_72dpi   |  | The capacity indicates the amount of usable space in the oven cavity in litres.                             |
|  | ...   |   |   |

---

## Benefit

---

### **True-convection**

The best cooking performances guaranteed by ventilated circular flow.

Multiple fans and heating elements guarantee the perfect aerodynamic heat flow, allowing homogeneous and quicker cooking inside the cavity.

### **Induction hob**

Induction offers fast cooking and precise temperature control

Through the use of suitable cookware, induction is easy to use and maintain, safe and responsive

### **Touch control**

Easy and intuitive timer setting with a single touch

### **Single turbine**

The oven has a fan equipped with a circular heating element allowing cooking with rotating heat

### **Isothermic Cavity**

The best cooking performance at the highest energy efficiency

### **Tangential cooling**

New cooling system with tangential fan and airflow from the door to the splashback

### **Pyrolysis**

Easy oven cleaning thanks to special pyrolytic function

### **Multilevel halogen light**

Internal halogen lighting on different levels guarantees excellent visibility

### **Telescopic guides**

Easy extraction and safe insertion of trays into the oven thanks to telescopic guides

### **Adjustable height**

Cooker top flushed with the working area thanks to adjustable feet

### **Removable inner glass**

Internal door glasses are easily removable for complete cleaning

### **Multilevel cooking**

Several cooking levels allow maximum flexibility of use

**Cold door**

During any function, the external door glass is cold, avoiding any risk of burns

**AirFry (AIRFRY optional accessory)**

Lighter and tastier food thanks to airfry basket

**BBQ (optional accessory)**

Barbeque cooking directly in the oven with the double-sided grill

**Pizza stone (optional accessory)**

Baking with refractory stone for soft and crispy pizza and yeast products (STONE optional accessory)